

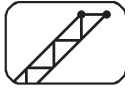

4,8-19,2m



2,1/5m



6,6x6,5m



fest

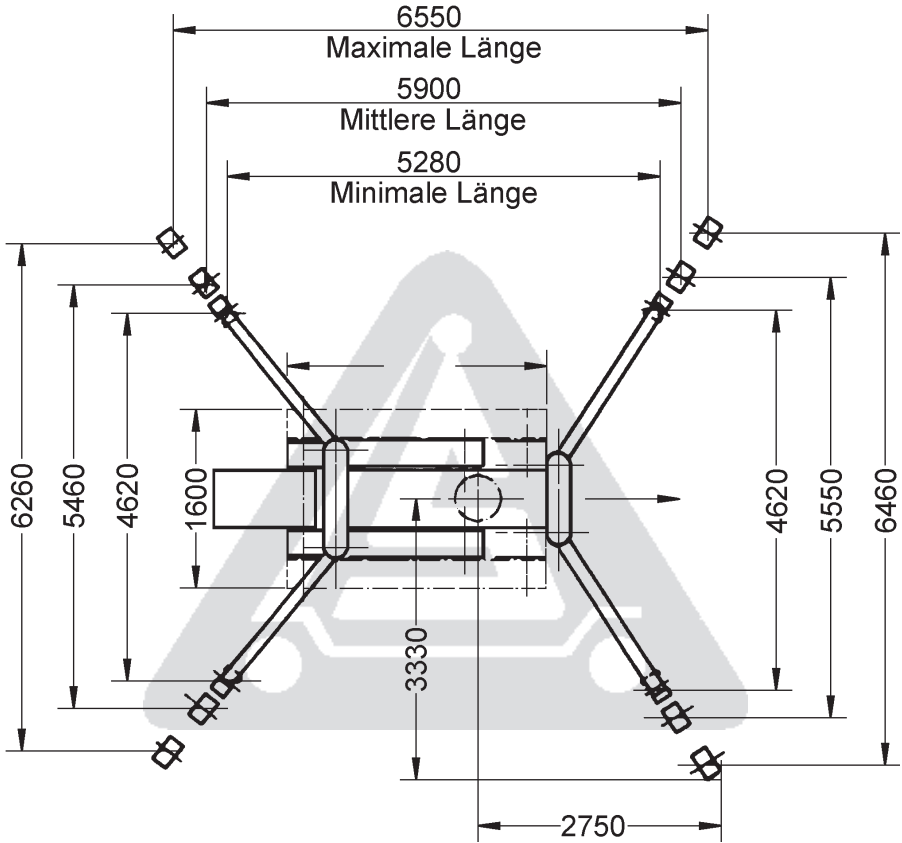

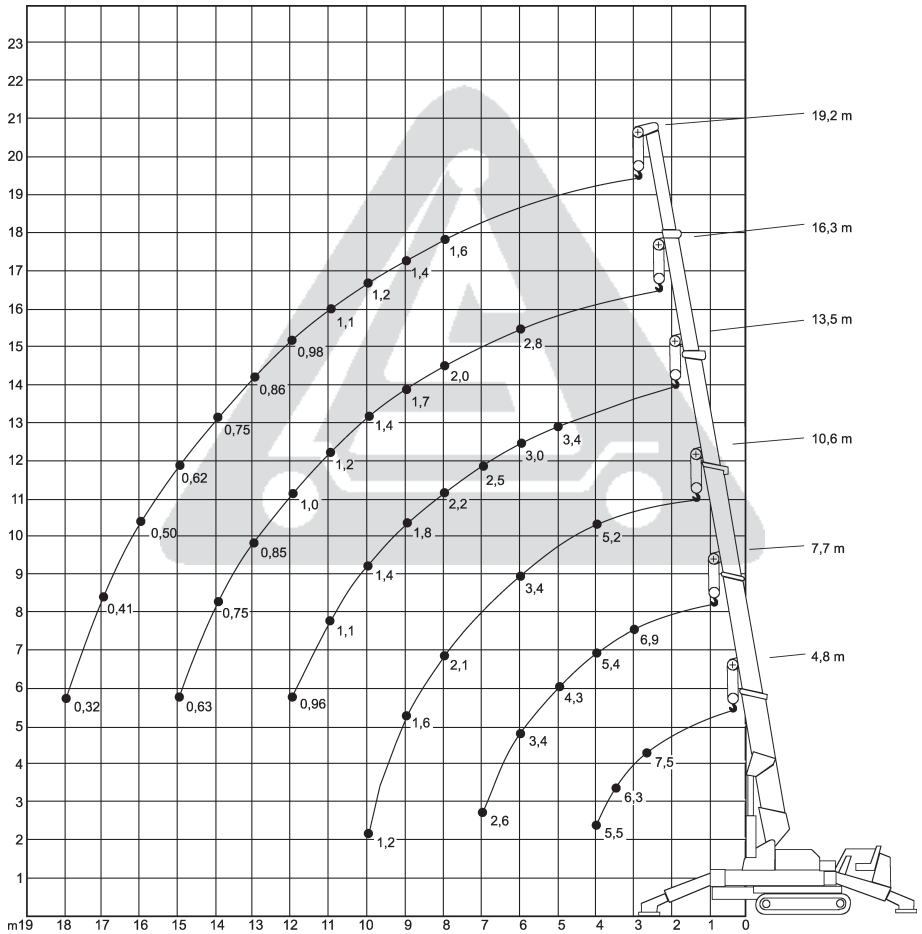



4,8-19,2m

6,6x6,5m

fest

360°

75%

Unic B-775

| | 4,8 | 7,7 | 10,6 | 13,5 | 16,3 | 19,2 | |
|------|-----|-----|------|------|------|------|------|
| 2,5 | 7,5 | | | | | | 2,5 |
| 3 | 7,2 | 6,9 | | | | | 3 |
| 3,5 | 6,3 | 6,1 | 5,2 | | | | 3,5 |
| 4 | 5,5 | 5,4 | 5,2 | | | | 4 |
| 5 | | 4,3 | 4,2 | 3,4 | | | 5 |
| 6 | | 3,4 | 3,4 | 3 | 2,8 | | 6 |
| 6,5 | | 3 | 3,1 | 2,7 | 2,6 | | 6,5 |
| 7 | | 2,6 | 2,8 | 2,5 | 2,3 | | 7 |
| 8 | | | 2,1 | 2,2 | 2 | 1,6 | 8 |
| 9 | | | 1,6 | 1,8 | 1,7 | 1,4 | 9 |
| 10 | | | 1,2 | 1,4 | 1,4 | 1,2 | 10 |
| 11 | | | | 1,1 | 1,2 | 1,1 | 11 |
| 12 | | | | 0,96 | 1 | 0,98 | 12 |
| 13 | | | | 0,6 | 0,85 | 0,86 | 13 |
| 14 | | | | | 0,75 | 0,75 | 14 |
| 15 | | | | | 0,63 | 0,62 | 15 |
| 16 | | | | | 0,45 | 0,5 | 16 |
| 17 | | | | | | 0,41 | 17 |
| 18 | | | | | | 0,32 | 18 |
| 18,6 | | | | | | 0,25 | 18,6 |



4,8-19,2m

5,9x5,5m

fest

360°

75%

| | 4,8 | 7,7 | 10,6 | 13,5 | 16,3 | 19,2 | |
|------|------|------|------|------|------|------|------|
| 2,5 | 6,6 | | | | | | 2,5 |
| 3 | 6,6 | 6,6 | | | | | 3 |
| 3,5 | 6 | 5,88 | 5 | | | | 3,5 |
| 4 | 5,33 | 5,22 | 5 | 3,24 | | | 4 |
| 5 | | 4,12 | 4,01 | 3,24 | 2,58 | | 5 |
| 6 | | 2,69 | 3,24 | 2,8 | 2,58 | 1,48 | 6 |
| 6,5 | | 2,28 | 2,58 | 2,4 | 2,1 | 1,48 | 6,5 |
| 7 | | 1,87 | 1,92 | 2,03 | 1,65 | 1,48 | 7 |
| 8 | | | 1,53 | 1,54 | 1,65 | 1,48 | 8 |
| 9 | | | 1,04 | 1,21 | 1,26 | 1,29 | 9 |
| 10 | | | 0,77 | 0,93 | 1,04 | 1,1 | 10 |
| 11 | | | | 0,71 | 0,82 | 0,9 | 11 |
| 12 | | | | 0,6 | 0,66 | 0,71 | 12 |
| 13 | | | | 0,44 | 0,55 | 0,6 | 13 |
| 14 | | | | | 0,44 | 0,5 | 14 |
| 15 | | | | | 0,33 | 0,42 | 15 |
| 16 | | | | | 0,27 | 0,33 | 16 |
| 17 | | | | | | 0,27 | 17 |
| 18 | | | | | | 0,22 | 18 |
| 18,6 | | | | | | 0,16 | 18,6 |



4,8-19,2m



5,3x4,6m

fest

360°

75%

Unic B-775

|  | 4,8 | 7,7 | 10,6 | 13,5 | 16,3 | 19,2 |  |
|---|-----|------|------|------|------|------|--|
| 2,5 | 6,6 | 6,6 | | | | | 2,5 |
| 3 | 6,6 | 6,6 | 5 | | | | 3 |
| 3,5 | 6 | 5,88 | 5 | 3,02 | | | 3,5 |
| 4 | 5 | 5,11 | 5 | 3,02 | 2,14 | | 4 |
| 5 | | 2,8 | 2,91 | 3,02 | 2,14 | 1,21 | 5 |
| 6 | | 1,81 | 1,87 | 2,03 | 2,14 | 1,21 | 6 |
| 6,5 | | 1,53 | 1,59 | 1,73 | 1,7 | 1,21 | 6,5 |
| 7 | | 1,26 | 1,32 | 1,43 | 1,25 | 1,21 | 7 |
| 8 | | | 0,93 | 1,1 | 1,15 | 1,21 | 8 |
| 9 | | | 0,71 | 0,82 | 0,88 | 1 | 9 |
| 10 | | | 0,49 | 0,6 | 0,71 | 0,77 | 10 |
| 11 | | | | 0,47 | 0,55 | 0,63 | 11 |
| 12 | | | | 0,36 | 0,44 | 0,5 | 12 |
| 13 | | | | 0,26 | 0,33 | 0,4 | 13 |
| 14 | | | | | 0,25 | 0,31 | 14 |
| 15 | | | | | 0,19 | 0,25 | 15 |
| 16 | | | | | 0,14 | 0,19 | 16 |
| 17 | | | | | | 0,15 | 17 |
| 18 | | | | | | 0,1 | 18 |
| 18,6 | | | | | | 0,07 | 18,6 |

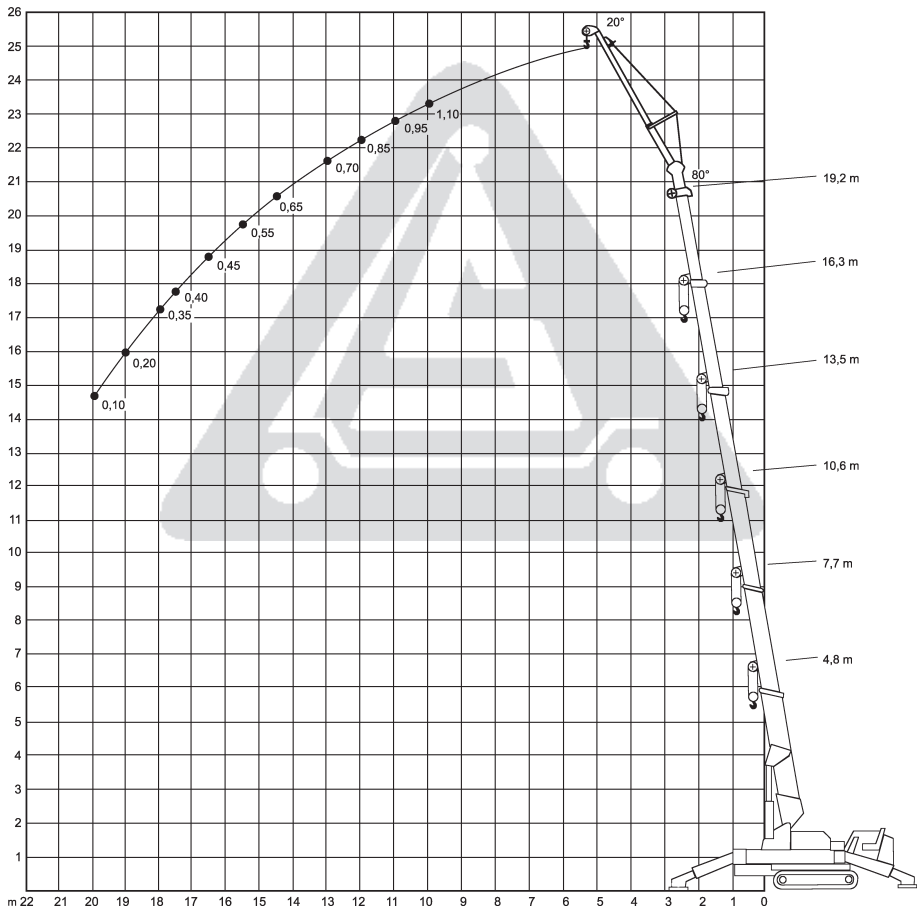

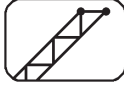

13,5-19,2m

5m

6,6x6,5m

fest

360°

75%

| | 13,5 20° | 16,3 20° | 19,2 20° | |
|------|---------------------------|---------------------------|---------------------------|------|
| 6 | 1,1 | 1,1 | 1,1 | 6 |
| 7 | 1,1 | 1,1 | 1,1 | 7 |
| 8 | 1,1 | 1,1 | 1,1 | 8 |
| 9 | 1,1 | 1,1 | 1,1 | 9 |
| 10 | 1,1 | 1,1 | 1,1 | 10 |
| 11 | 0,95 | 0,95 | 0,95 | 11 |
| 12 | 0,85 | 0,85 | 0,85 | 12 |
| 13 | 0,7 | 0,7 | 0,7 | 13 |
| 14,5 | 0,65 | 0,65 | 0,65 | 14 |
| 15,5 | 0,55 | 0,55 | 0,55 | 15,5 |
| 16,5 | | 0,45 | 0,45 | 16,5 |
| 18 | | 0,35 | 0,35 | 18 |
| 19 | | | 0,2 | 19 |
| 20 | | | 0,1 | 20 |

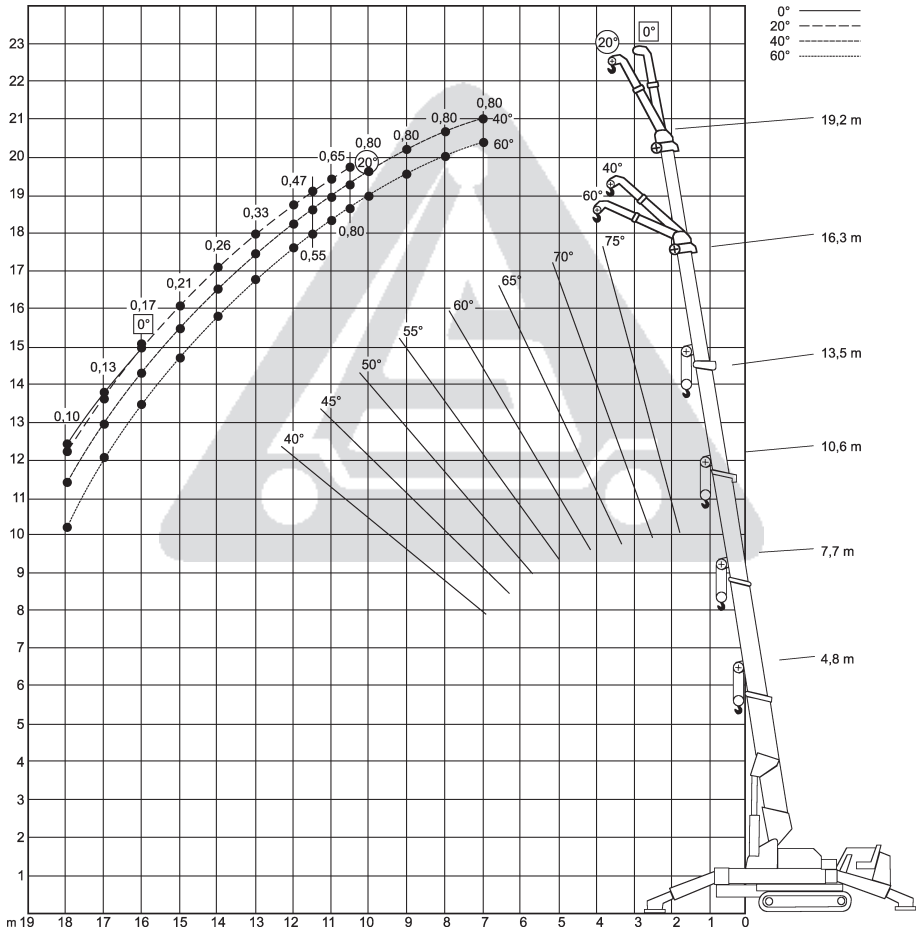



19,2m

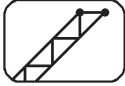

2,1m



6,6x6,5m



fest



360°



75%

| | 19,2 | | | | |
|------|------|------|------|------|------|
| | 60° | 40° | 20° | 0° | |
| 6 | 0,8 | 0,8 | | | 6 |
| 7 | 0,8 | 0,8 | | | 7 |
| 8 | 0,8 | 0,8 | | | 8 |
| 9 | 0,8 | 0,8 | | | 9 |
| 10 | 0,8 | 0,8 | | | 10 |
| 10,5 | 0,8 | 0,8 | | | 10,5 |
| 11 | 0,65 | 0,65 | 0,65 | | 11 |
| 11,5 | 0,55 | 0,55 | 0,55 | | 11,5 |
| 12 | 0,47 | 0,47 | 0,47 | | 12 |
| 13 | 0,33 | 0,33 | 0,33 | | 13 |
| 14 | 0,26 | 0,26 | 0,26 | | 14 |
| 15 | 0,21 | 0,21 | 0,21 | | 15 |
| 16 | 0,17 | 0,17 | 0,17 | 0,17 | 16 |
| 17 | 0,13 | 0,13 | 0,13 | 0,13 | 17 |
| 18 | 0,1 | 0,1 | 0,1 | 0,1 | 18 |



